

OPIS TECHNICZNY

ogólny

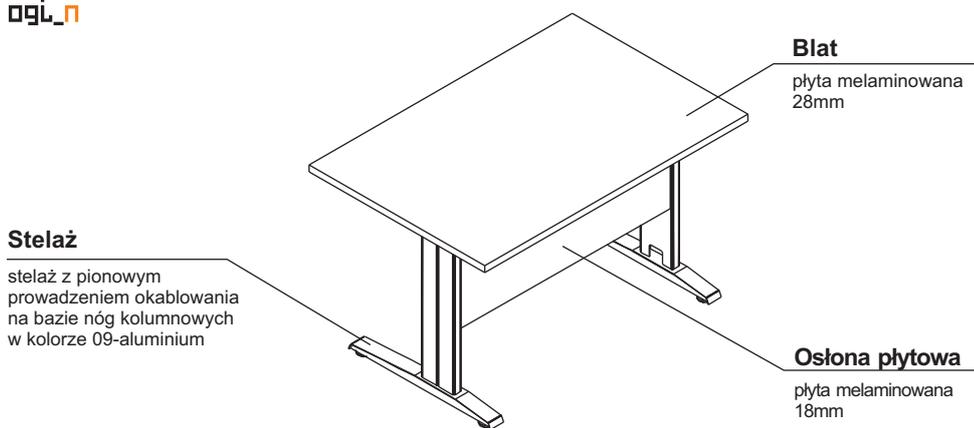

ogólny

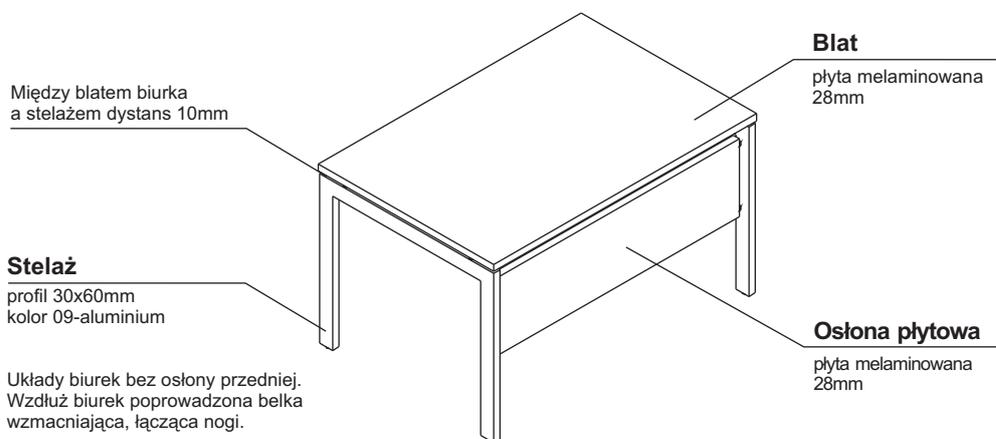

ogólny

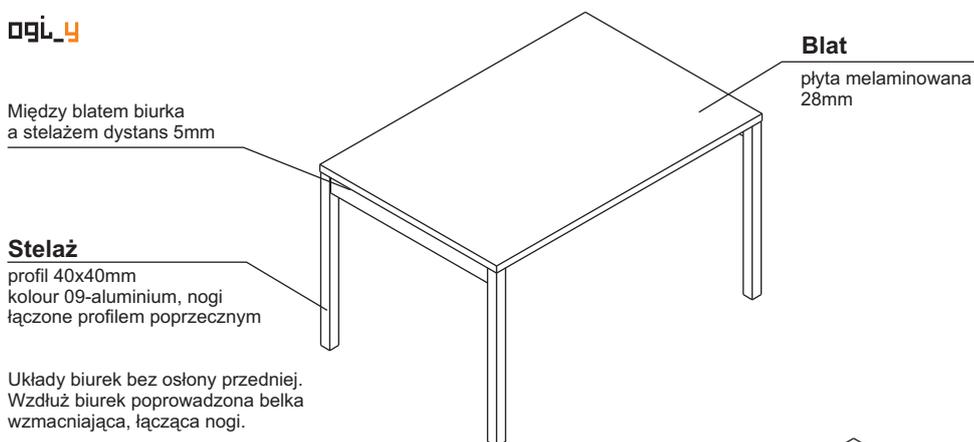

ogólny

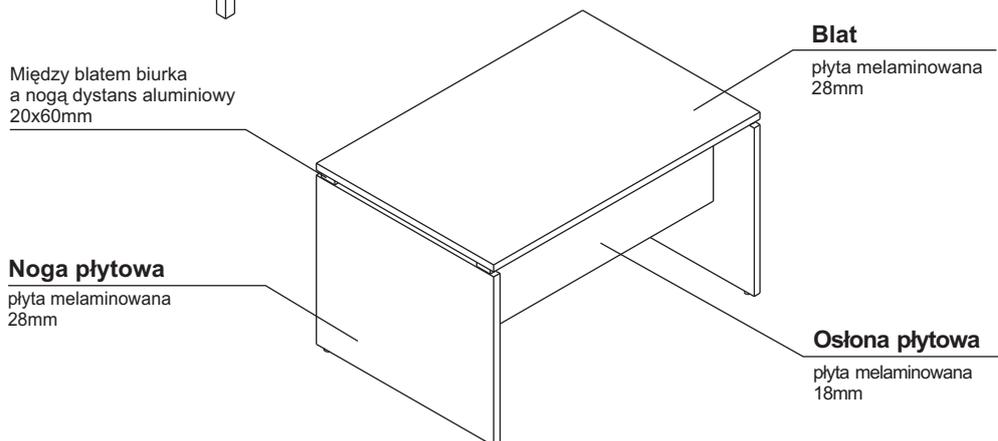

OPIS TECHNICZNY

BIURKO MANAGERSKIE

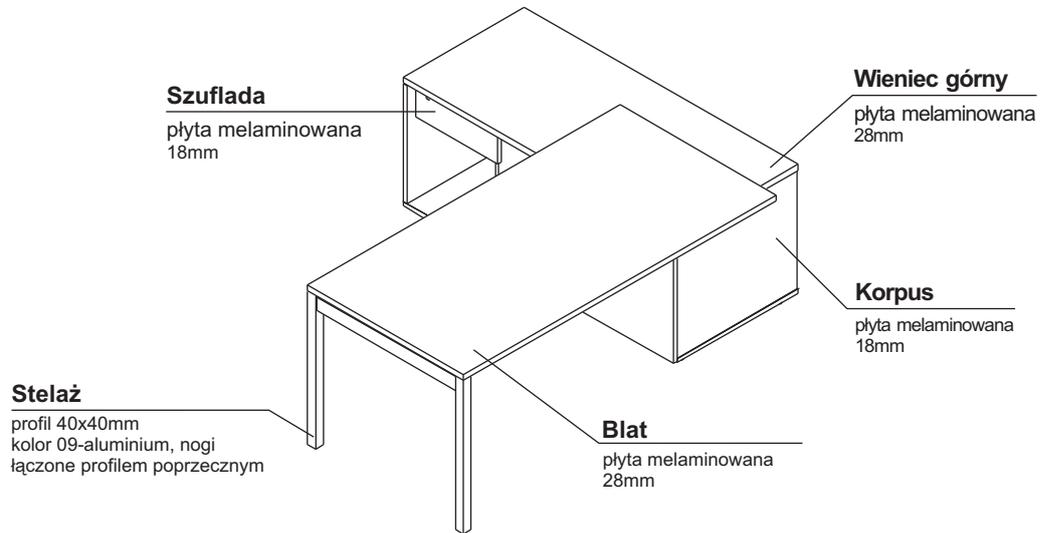

PANELE DZIELĄCE - PŁYTOWE Z PODUSZKAMI TKANINOWYMI

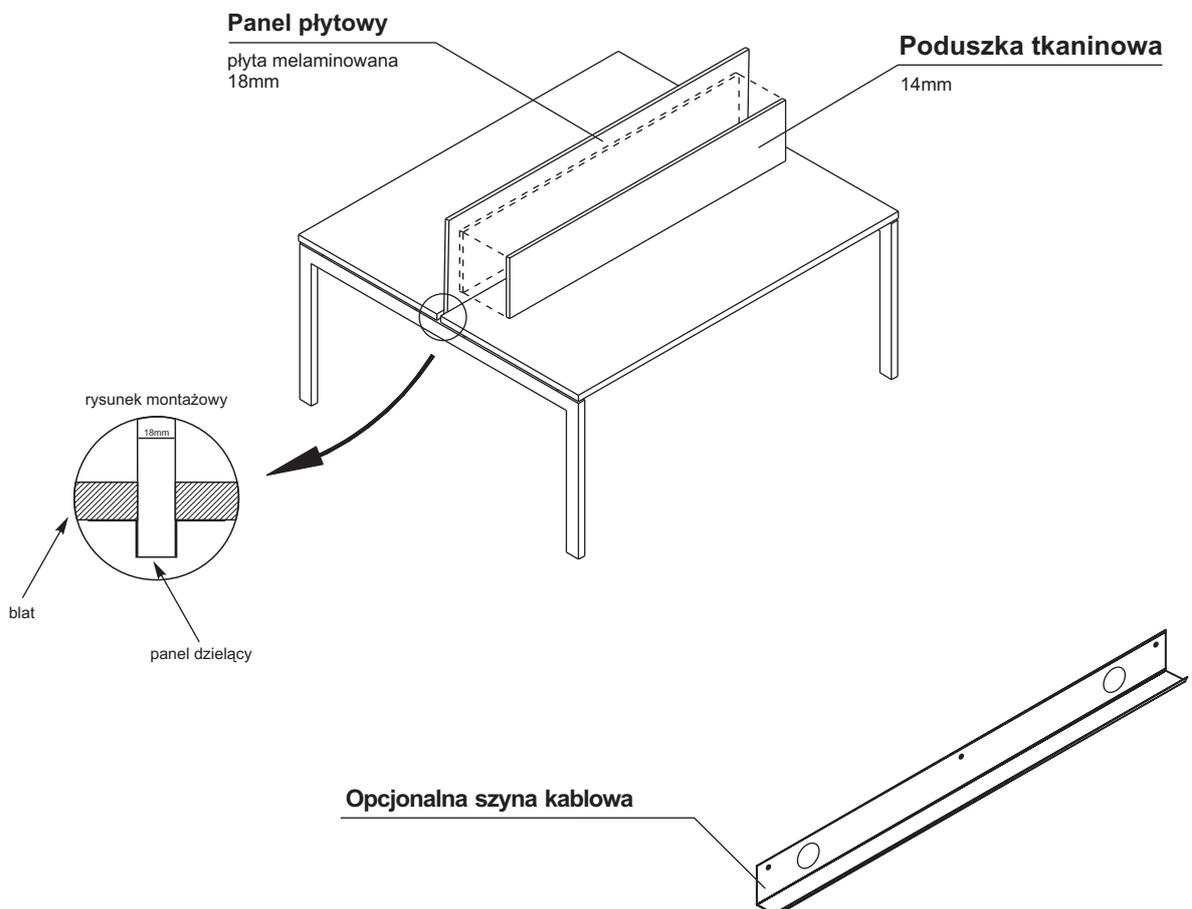

OPIS TECHNICZNY

SZAFY

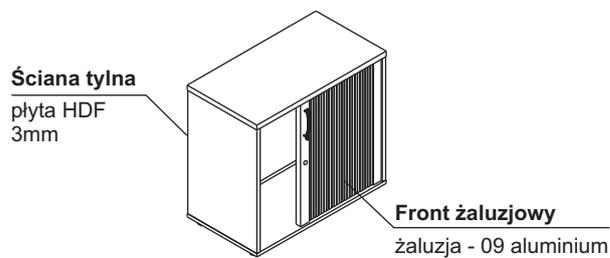
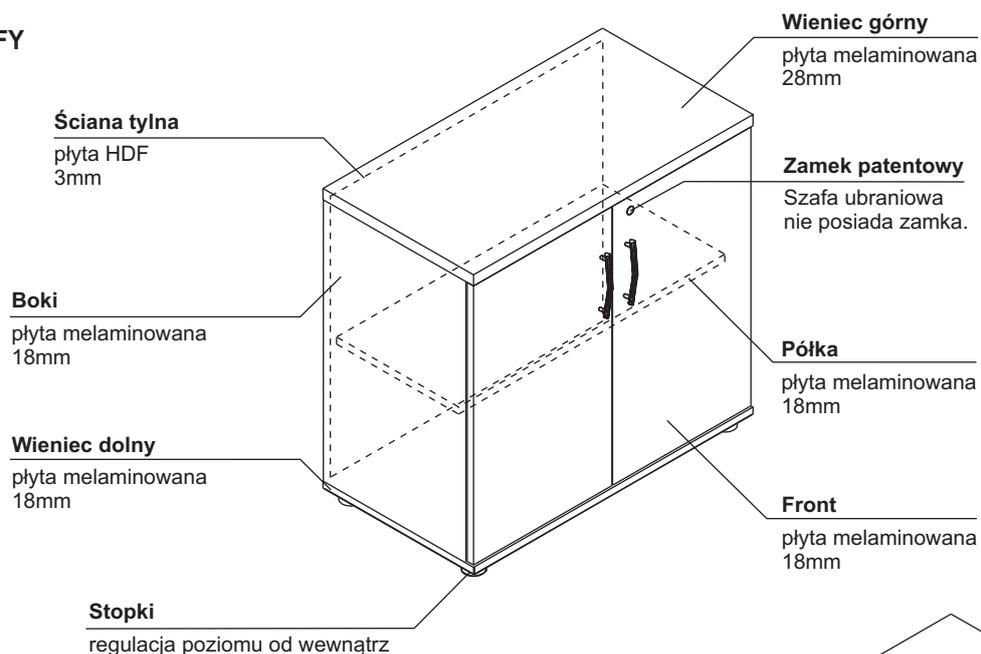

KONTENERY

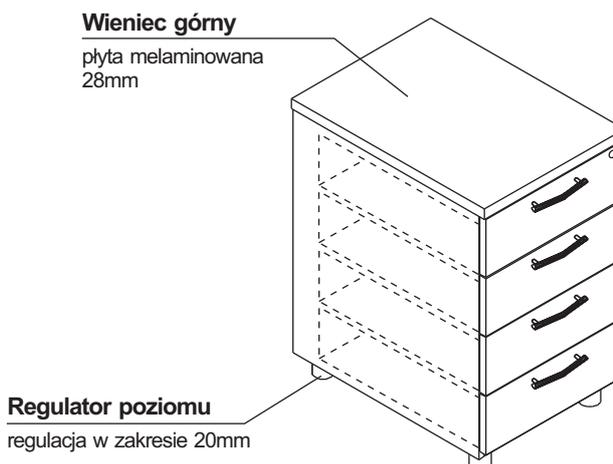
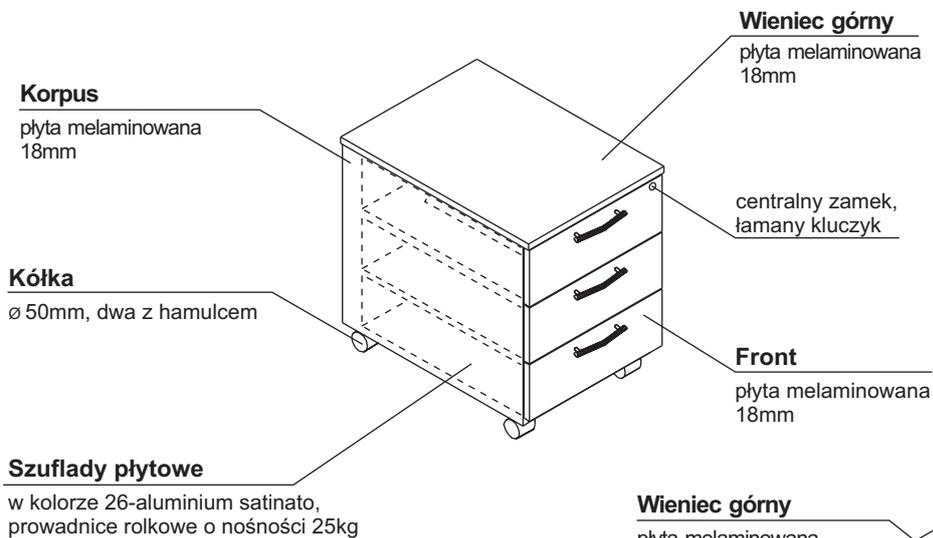

KOLORYSTYKA

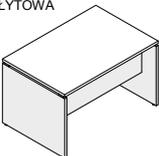
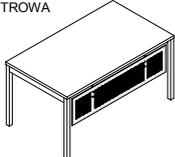
BLAT		14-BUK 31-DĄB KANADYJSKI 34-KASZTAN 39-BRZOZA POLARNA 64-COCOA 67-BIAŁY PASTEL 106-ORZECH NIZINNY		
STELAŻ		09-ALUMINIUM	STELAŻ I OSŁONA PLYTOWA OGI V 	26-ALUMINIUM SATINATO
PRZYSTAWKA		14-BUK 31-DĄB KANADYJSKI 34-KASZTAN 39-BRZOZA POLARNA 64-COCOA 67-BIAŁY PASTEL 106-ORZECH NIZINNY		
NOGA PODPIERAJĄCA		09 - ALUMINIUM		
OSŁONA PLYTOWA		OGI Y 14-BUK 26-ALUMINIUM SATINATO 31-DĄB KANADYJSKI 34-KASZTAN 39-BRZOZA POLARNA 64-COCOA 67-BIAŁY PASTEL 106-ORZECH NIZINNY	OGI N, U 26 - ALUMINIUM SATINATO	
PANEL DZIELĄCY		26 - ALUMINIUM SATINATO	OSŁONA RASTROWA 	09 - ALUMINIUM
PODUSZKA TKANINOWA		NX2 - BEŻOWY NX3 - POMARAŃCZOWY NX5 - CZERWONY NX9 - ZIELONY NX10 - SZARY NX15 - GRANATOWY		
WIENIEC GÓRNY I FRONT		14-BUK 31-DĄB KANADYJSKI 34-KASZTAN 39-BRZOZA POLARNA 64-COCOA 67-BIAŁY PASTEL 106-ORZECH NIZINNY		
KORPUS I ŚCIANA TYLNA HDF		26 - ALUMINIUM SATINATO		

BIURKA

	ogł_n	ogł_u	ogł_y	ogł_u
BIURKA PROSTE I KSZTAŁTOWE				
	<b>BN02</b>	<b>BU02</b>	<b>BY02</b>	<b>BV02</b>
	<b>BN03</b>	<b>BU03</b>	<b>BY03</b>	<b>BV03</b>
	<b>BN04</b>	<b>BU04</b>	<b>BY04</b>	<b>BV04</b>
	<b>BN05</b>	<b>BU05</b>	<b>BY05</b>	<b>BV05</b>
	<b>BN10</b>	<b>BU10</b>	<b>BY10</b>	<b>BV10</b>
	<b>BN11</b>	<b>BU11</b>	<b>BY11</b>	<b>BV11</b>
	<b>BN17</b>	<b>BU17</b>	<b>BY17</b>	<b>BV17</b>
	<b>BN18</b>	<b>BU18</b>	<b>BY18</b>	<b>BV18</b>
	-	<b>BU15</b>	<b>BY15</b>	-

\* biurka na  
wspólnej nodze

**Uwaga:** ! Do biurka kształtowych B\_10, B\_11, B\_15 należy zastosować odpowiednią ilość nóg podpierających NK41.

WIDOK I RZUT OBIEKTU	WYMIARY (mm)			INDEX / SYMBOL	UWAGI
	Szerokość a / a'	Głębokość b / b'	Wysokość h		

**UKŁADY BIUREK „BU” (możliwość montażu paneli)**

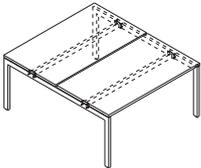
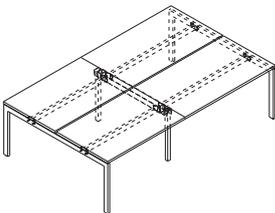
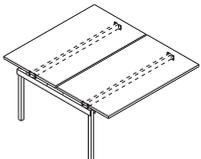
	1200	1618	720	<b>BU32</b>	
	1400			<b>BU33</b>	
	1600			<b>BU34</b>	
	2400	1618	720	<b>BU54</b>	BU32, BU12
	2600			<b>BU55</b>	BU32, BU13
	2800			<b>BU56</b>	BU33, BU13
	3000			<b>BU57</b>	BU33, BU14
	3200			<b>BU58</b>	BU34, BU14
	1200	1618	720	<b>BU12</b>	- element do rozbudowy układów
	1400			<b>BU13</b>	
	1600			<b>BU14</b>	

! Układy biurek bez osłony przedniej. Wzdłuż biurek poprowadzona belka wzmacniająca, łącząca nogi.

**ETAPY TWORZENIA UKŁADÓW WIELOSTANOWISKOWYCH TYPU „BU” ORAZ „BY”**

**ETAP I** - wybór odpowiedniej ilości elementów i montaż części stelażu z ostatnim elementem do rozbudowy układów

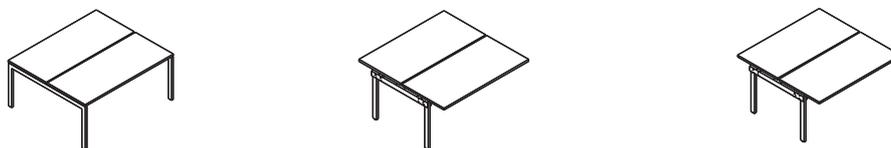

**ETAP II** - montaż układu wielostanowiskowego

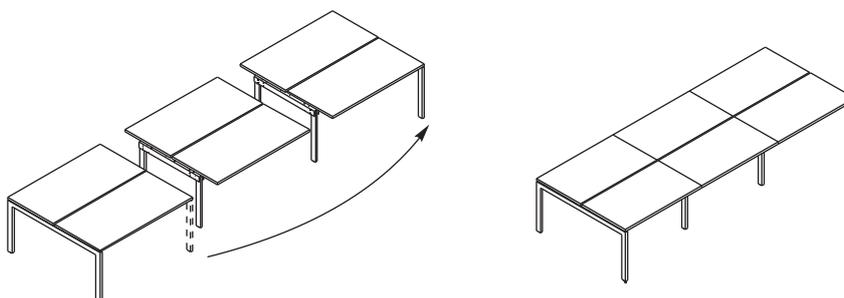

WIDOK I RZUT OBIEKTU	WYMIARY (mm)			INDEX / SYMBOL	UWAGI
	Szerokość a / a'	Głębokość b / b'	Wysokość h		

**UKŁAD BIUREK TYPU „BY” (możliwość montażu paneli)**

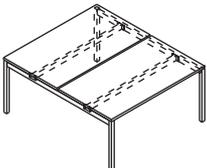
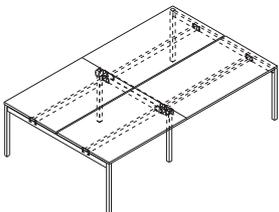
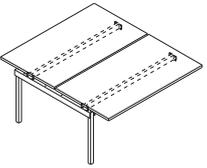
	1200	1618	720	<b>BY32</b>	
	1400			<b>BY33</b>	
	1600			<b>BY34</b>	
	2400	1618	720	<b>BY54</b>	BY32, BY12
	2600			<b>BY55</b>	BY32, BY13
	2800			<b>BY56</b>	BY33, BY13
	3000			<b>BY57</b>	BY33, BY14
	3200			<b>BY58</b>	BY34, BY14
	1200	1618	720	<b>BY12</b>	- element do rozbudowy układów
	1400			<b>BY13</b>	
	1600			<b>BY14</b>	

! Układy biurek bez osłony przedniej. Wzdłuż biurek poprowadzona belka wzmacniająca, łącząca nogi.

**BIURKO MANAGERSKIE**

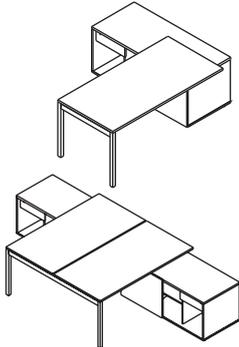
	1600	800 (1600)	720	<b>BY20</b>	
	1600	1618 (3218)	720	<b>BY40</b>	

**STOLIK**

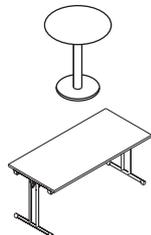
	ø 550	-	640	<b>PS2</b>	- stolik z blatem szklanym - stelaż w kolorze 09-aluminium
	1600	750	725	<b>PSU06</b>	- stół składany - stelaż w kolorze chrom - blat w kolorze 26-aluminium satynato

WIDOK I RZUT OBIEKTU	WYMIARY (mm)			INDEX / SYMBOL	UWAGI
	Szerokość a / a'	Głębokość b / b'	Wysokość h		

**STOŁY TYPU "PO"**

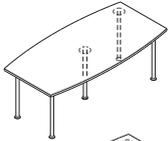
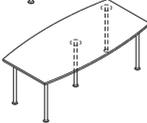
	2400	1000	720	<b>PO52</b>	
	2000	1000	720	<b>PO41</b>	
	-	∅ 800	500	<b>PO26</b>	
	800	800	500	<b>PO27</b>	
	-	∅ 800	720	<b>PO28</b>	
	800	800	720	<b>PO29</b>	
	1400	800	720	<b>PO31</b>	

**PRZYSTAWKI I ŁĄCZNIKI - MELAMINA**

	800	600	-	<b>PK02</b>	- w cenę nie wliczono nóg podpierających NK41 (2 szt.)
	1000	600	-	<b>PK11</b>	- w cenę nie wliczono nóg podpierających NK41 (1 szt.)
	1200	600	-	<b>PK12</b>	- w cenę nie wliczono nóg podpierających NK41 (2 szt.)
	1600	600	-	<b>PK16</b>	- w cenę nie wliczono nóg podpierających NK41 (2 szt.)
	800	800	-	<b>PK40</b>	- w cenę nie wliczono nóg podpierających NK41 (1 szt.)
	800	600	-	<b>PK17</b>	
	1200	600	-	<b>PK18</b>	

- w cenę nie wliczono nóg podpierającej NK41



WIDOK I RZUT OBIEKTU	WYMIARY (mm)			INDEX / SYMBOL	UWAGI
	Szerokość a / a'	Głębokość b / b'	Wysokość h		

**PRZYSTAWKI I ŁĄCZNIKI - MELAMINA**

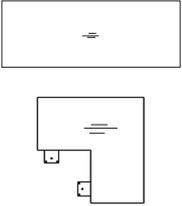
	1600	600	-	<b>PK19</b>	
	600	600	-	<b>PK27</b>	- w cenie nie wliczono nóg podpierających NK41 (1 szt.)

**NOGA PODPIERAJĄCA**

	∅ 40	-	690	<b>NK41</b>	
---	------	---	-----	-------------	--

**OSŁONY PRZEDNIE DO BIUREK - PŁYTOWE**

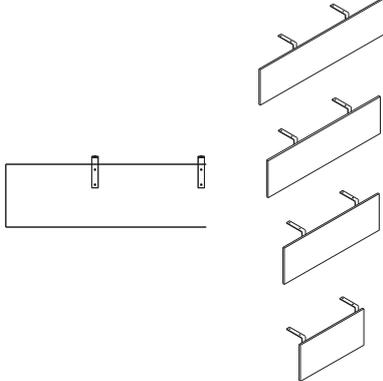
	1600	18	400	<b>UK5</b>	- panel do biurek „BY” 1800mm
	1400	18	400	<b>UK4</b>	- panel do biurek „BY” 1600mm
	1200	18	400	<b>UK3</b>	- panel do biurek „BY” 1400mm
	1000	18	400	<b>UK2</b>	- panel do biurek „BY” 1200mm

**OSŁONY PRZEDNIE DO BIUREK - RASTROWE**

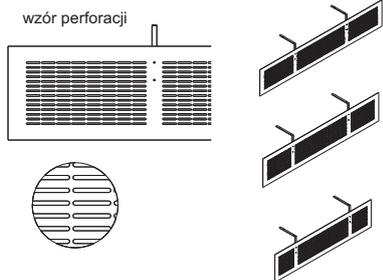
<p>wzór perforacji</p> 	1600	15	300	<b>UK16</b>	- panel do biurek „BY” 1800mm
	1400	15	300	<b>UK15</b>	- panel do biurek „BY” 1600mm
	1200	15	300	<b>UK14</b>	- panel do biurek „BY” 1400mm

**PANELE DZIELĄCE - PŁYTOWE**

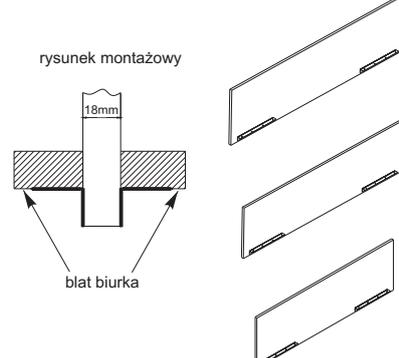
<p>rysunek montażowy</p> 	1700	18	384	<b>RK17</b>	- podana wysokość ponad blat biurka
	1500	18	384	<b>RK15</b>	
	1300	18	384	<b>RK13</b>	

WIDOK I RZUT OBIEKTU	WYMIARY (mm)			INDEX / SYMBOL	UWAGI
	Szerokość a / a'	Głębokość b / b'	Wysokość h		

**PANELE DZIELĄCE - PŁYTOWE**

	1100	18	384	<b>RK11</b>	- podana wysokość ponad blat biurka
---	------	----	-----	-------------	-------------------------------------

**PANELE DZIELĄCE - PŁYTOWE Z PODUSZKAMI**

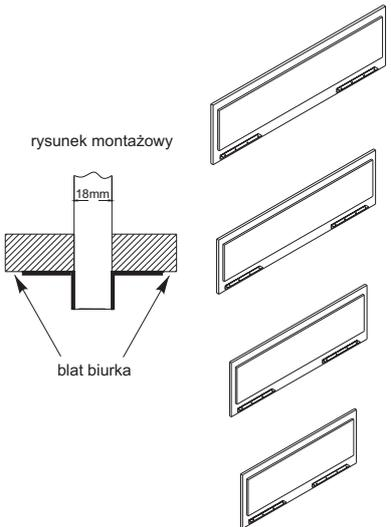
	1700	46	384	<b>RK17P</b>	- panel płytowy z obustronnie zamontowaną poduszką tkaninową  - podana wysokość ponad blat biurka
	1500	46	384	<b>RK15P</b>	
	1300	46	384	<b>RK13P</b>	
	1100	46	384	<b>RK11P</b>	

**SZAFY I REGAŁY 5 OH - MELAMINA**

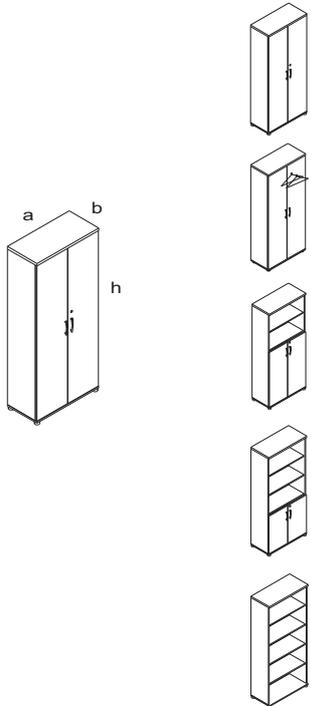
	802	385	1833	<b>K5104</b>	
	802	385	1833	<b>K5204</b>	- ubraniowa z wieszakiem wysuwnym
	802	385	1833	<b>K5304</b>	
	802	385	1833	<b>K5404</b>	
	802	385	1833	<b>K5504</b>	

**SZAFY I REGAŁY 3 OH - MELAMINA**

	802	385	1129	<b>K3104</b>	
---	-----	-----	------	--------------	--

WIDOK I RZUT OBIEKTU	WYMIARY (mm)			INDEX / SYMBOL	UWAGI
	Szerokość a / a'	Głębokość b / b'	Wysokość h		

**SZAFY I REGAŁY 3 OH - MELAMINA**

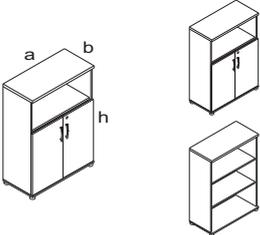
	802	385	1129	<b>K3404</b>	
	802	385	1129	<b>K3504</b>	

**SZAFY I REGAŁY 2 OH - MELAMINA**

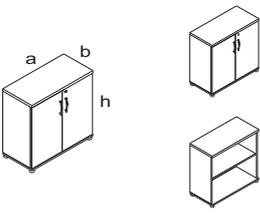
	802	385	777	<b>K2104</b>	
	802	385	777	<b>K2504</b>	

**NADSTAWKI 2 OH - MELAMINA**

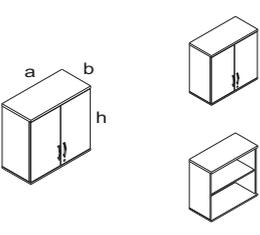
	802	385	750	<b>K1104</b>	- zamek w lewym skrzydle drzwi - wieniec dolny w kolorze 26-aluminium satinato
	802	385	750	<b>K1504</b>	- wieniec dolny w kolorze 26-aluminium satinato

**SZAFY ŻALUZYJOWE - MELAMINA**

	1200	385	1129	<b>K3Z06</b>	- korpus i wieniec górny 26 - aluminium satinato - żaluzja 09 - aluminium
---	------	-----	------	--------------	--

**SZAFKA POD KSERO**

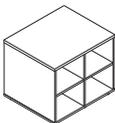
	710	600	600	<b>S85</b>	- szafka pod ksero, cała w kolorze 26-aluminium satinato
---	-----	-----	-----	------------	--

**KONTENERY Z SZUFLADAMI PŁYTOWYMI**

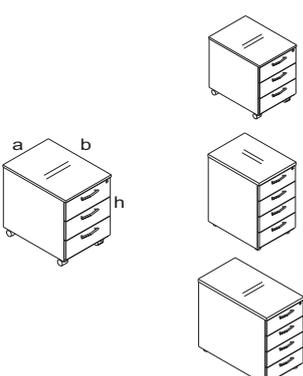
	434	525	580	<b>KK13</b>	
	434	600	720	<b>KK64</b>	
	434	800	720	<b>KK74</b>	

WIDOK I RZUT OBIEKTU	WYMIARY (mm)			INDEX / SYMBOL	UWAGI
	Szerokość a / a'	Głębokość b / b'	Wysokość h		

**ELEMENTY DODATKOWE DO BIUREK I SZAF**

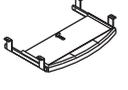
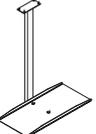
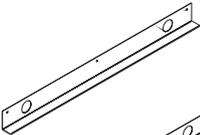
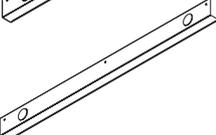
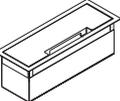
	800	5	1050	<b>KS310</b>	- kpl. drzwi szklanych 3 OH - szkło hartowane, bezbarwne
	800	20	1050	<b>KS300</b>	- kpl. drzwi szklanych 3 OH z ramką aluminiową - szkło hartowane, mleczne
	-	-	-	<b>S86</b>	- wieszak wysuwany
	610	400	85	<b>C01</b>	- półka pod klawiaturę kolor tylko 02 szary, do biurek na gł. 800mm
	-	-	-	<b>AK3</b>	- rzepy do mocowania kabli, szare (3 z wkrętami, 3 bez wkrętów)
	220	470	148	<b>S73</b>	- wózek na stację dysków kolorystyka 26-aluminium satinato
	140	70	750	<b>S81</b>	- prowadzenie kabli (kregostup) kolor 09-aluminium
	1000	70	35	<b>S82</b>	- grzebień do mocowania kabli pod blatem
	-	460	617	<b>S83</b>	- zawieszanie do komputera
	1186	64	100	<b>EG14</b>	- szyny do mocowania kabli do biurek „BU” oraz „BY”
	1386	64	100	<b>EG16</b>	
	145	80	3	<b>E40</b>	- 2 szt. - kolor 08-czarny
	300	110	-	<b>M01</b>	- 4 x 230V, gniazdo zasilające - 2 x RJ45, gniazdo sieciowe (klasa E, kategoria 6)
	∅ 80	-	-	<b>PK80</b>	- przelot kablowy ∅ 80mm

**UMIEJSCOWIENIE MEDIABOX M01**

BIURKA PROSTE



BIURKA KSZTAŁTOWE



opcję należy dopisać na końcu symbolu wyrobu oraz doliczyć wartość mediabox M01 do ceny biurka:

np.

BU02M

**UMIEJSCOWIENIE PRZELOTU KABLOWEGO PK80 - BIURKA**

BIURKA PROSTE



BIURKA KSZTAŁTOWE

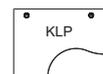

np.. BU02KLP

**UMIEJSCOWIENIE PRZELOTÓW KABLOWYCH PK80 - UKŁADY BIUREK**

