



Omnispace

C+P Möbelsysteme GmbH & Co. KG
Boxbachstr. 1
D - 35236 Breidenbach
Tel. +49 6465 / 919-340
Fax +49 6465 / 919-349
e-Mail info@cpmoebel.de
www.cpmoebel.de

Furniture for people





Visualisation of the functional area requirements of a tambour cupboard.

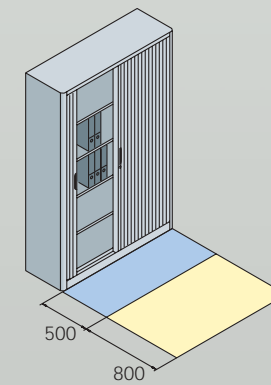

Compared with a 2 door cabinet.

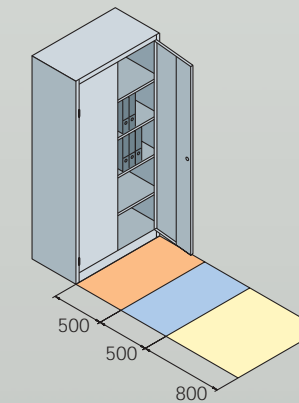

- = functional area
- = user area
- = service area

Omnispace: small footprint, large capacity

Office accommodation is expensive. A good idea then, to use intelligent, cabinet storage systems to make the most of the space available. Technically competent, with excellent quality and high functionality, as well as good looking designs, Omnispace tambour cupboards make a perfect storage interior for any office. Furthermore, the variety of interior fitment solutions ensures that every mm of space is fully utilised.

Omnispace tambour cupboards do not require the same functional area as the one required by 2 door cabinets. This saves space and cost. In addition, the handling is easy and comfortable – easy-slide opening gives instant access to all the contents, allowing smooth and uninterrupted working and greater efficiency.

All models and size variations at a glance

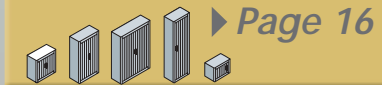

Easy-slide tambour doors in recyclable plastic, fitted with a hook-over lock and two keys. There is a practical moulded grip inset into the door.



The shelves are adjustable on a roster of 15 mm punched into the side skins. They are well suited for file storage or under shelf lateral filling pockets. With an even weight distribution the shelves will carry up to 50 kgs.



Making the most of the office. With Omnispace

Getting the most from your office space whilst complying with current regulations is easier than you might assume.

Using Omnispace gives the best opportunity to arrange storage space efficiently and still have all the interior at your fingertips. As there is no functional space, as required by hinged doors, both the footprint of and access to the Omnispace series are superior.

The reduced footprint means:

- More workstations and storage on a given footprint.
- A more generous lay-out using the same footprint.
- A more cost-effective use of office space.

The examples on these two pages illustrate these advantages.

Examples of actual space plans implemented using Omnispace tambour cabinets for best use of office space.

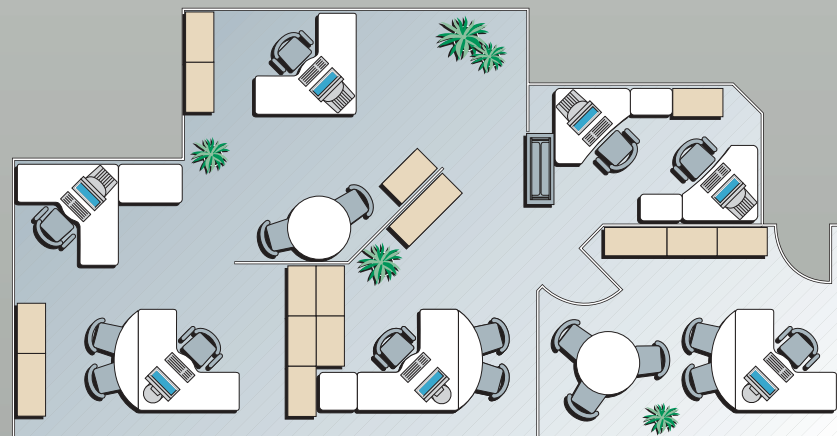
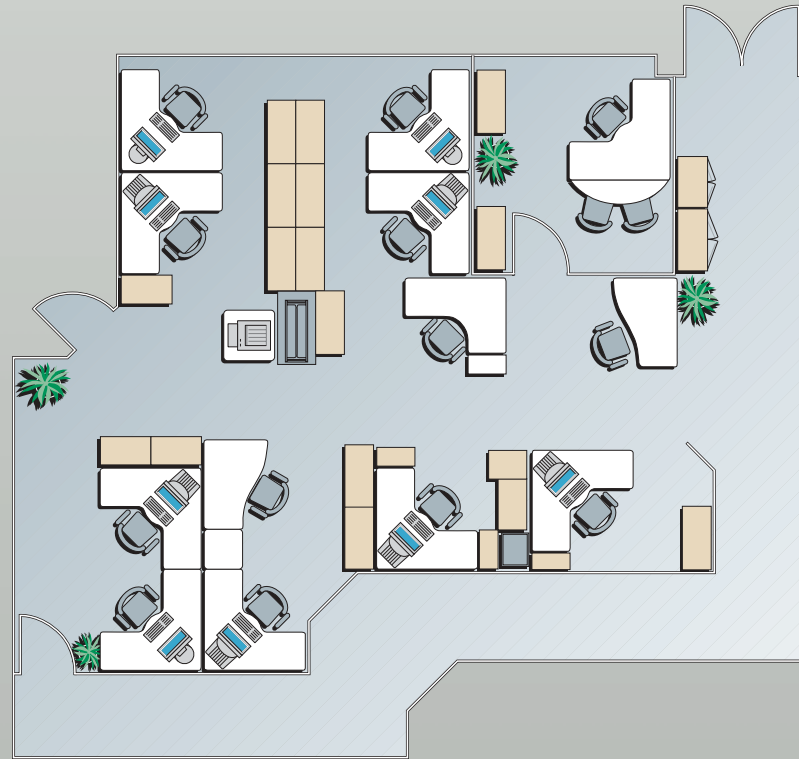

Source: Cadence in Boulogne-Billancourt, France

Example of an office furnished with 2 door cabinets. As the doors open into the middle of the office, a functional area is required which uses more space.

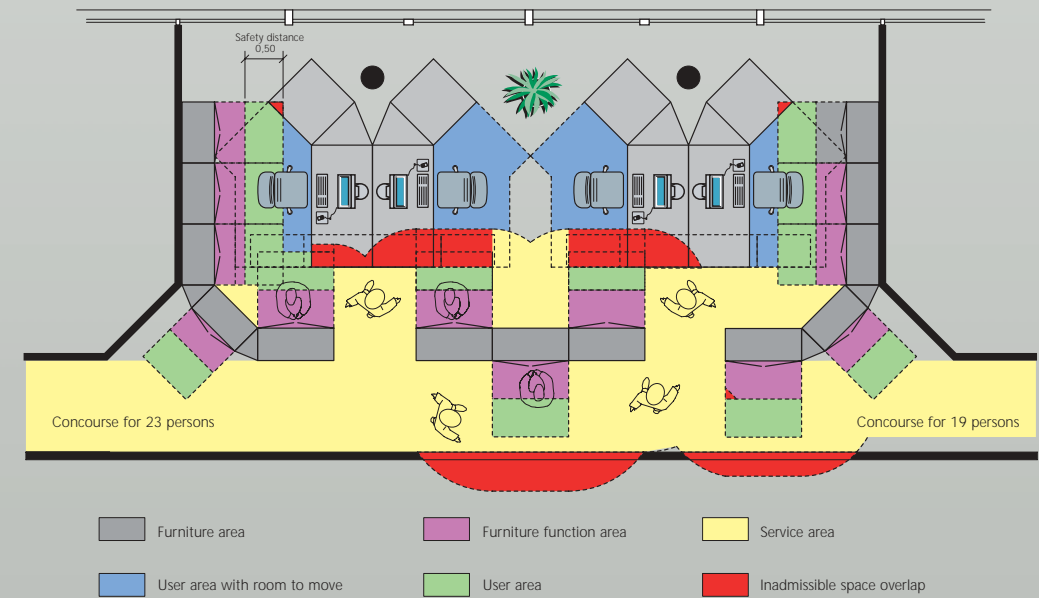

Omnispace is different. With the same area for the same workstations and the same storage space we maximise the accommodation for employees whilst adhering to workplace regulations.

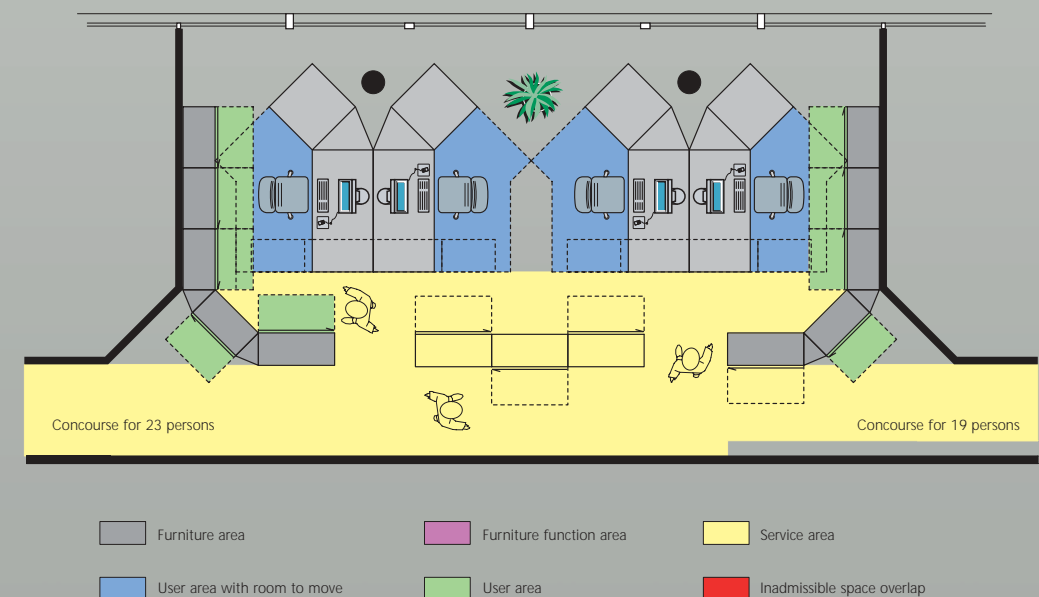

Source: Breidenstein + Reichenbach/Linden, Germany

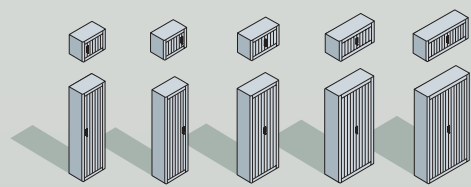

Operating at a high level

No need to lose the space between the top of the cabinet and the ceiling.

Using the full height of the office space creates additional storage for those files which are not required regularly but when needed they are not far away and save the trip to the archives. Omnispace stack-on units are ideal for this application. With stack-on units to match all cabinet widths the combination and expansion of storage runs is possible for all users, giving an already efficient installation, an integrated design appearance.

Omnispace conquers space!



Multidrawer unit for 15 drawers to fit a cabinet width of 800 mm or for 20 drawers to fit a width of 1200 mm



1 Tambour door cabinet with 4 adjustable shelves. Carcass and tambour door finished in white aluminium RAL 9006.
H 1980 x W 1200 x D 420 mm
Order No. 3203-00

2 Tambour door cabinet with stack-on unit. Carcass and tambour door finished in white aluminium RAL 9006.
H 450 x W 1200 x D 420 mm
Order No. 3263-00

All models and size variations at a glance

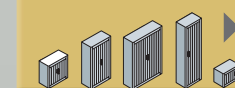

► Page 16

All colours, laminate finishes and accessories currently available are shown on pages 14 + 15.



3 Tambour door cabinet with 4 adjustable shelves. Carcass and tambour door finished in white aluminium RAL 9006.
Height 1980 x width 1200 x depth 420 mm
Order No. 3203-00

Pull out work shelf
Order No. 3203-871

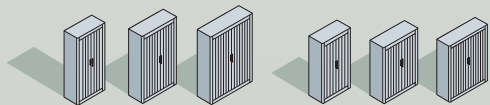

Communication or discretion?
Against the wall or dividing
space freestanding? Three, four
or five high cabinets? With
Omnispace, the choice is yours.

The right decision at all levels!

- 1 Tambour door cabinet** with 3 adjustable shelves. Carcass and door finished in white aluminium RAL 9006
H 1345 x W 1200 x D 420 mm
Order No. 3223-00

Top shelf maple laminate 5000-04
H 25 x W 1200 x D 420 mm
Order No. 3212-12

- 2 Tambour door cabinet** with 3 adjustable shelves. Carcass and door finished in white aluminium RAL 9006
H 1660 x W 1200 x D 420 mm
Order No. 3213-00

Top shelf maple laminate 5000-04
H 25 x W 1200 x D 420 mm
Order No. 3212-12

- 3 Tambour door cabinet** with 4 adjustable shelves. Carcass and door finished in white aluminium RAL 9006.
Height 1980 x width 1200 x depth 420 mm
Order No. 3203-00

- 4 Tambour door stack-on unit.**
Carcass and door finished in white aluminium RAL 9006.
H 450 x W 1200 x D 420 mm
Order No. 3263-00

All colours, laminate finishes and accessories currently available are shown on pages 14 + 15.



*Tambour door cabinet with 3 adjustable shelves. Carcass RAL 7021 anthracite; tambour door in beech laminate 5000-05
H 1660 x W 1200 x D 420 mm
Order No. 3213-00*

*Top shelf beech laminate 5000-05
H 25 x W 1200 x D 420 mm
Order No. 3212-12*



Laminate finish tops for good looks and hard wearing surfaces on counters and desk height work surfaces.



All models and size variations at a glance

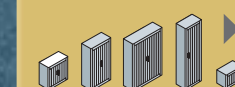

► Page 16

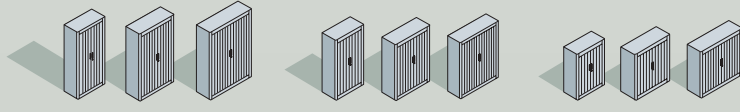

Tambour door cabinet with lateral file pockets, 2 adjustable shelves. Carcass RAL 9006 white aluminium. Doors maple finish. (upcharge option). H 1030 x W 1200 x D 420 mm Order No. 3243-65



Tambour door cabinet with lateral file pockets, 3 adjustable shelves. Carcass and door in RAL 7035 light grey. H 1345 x W 1200 x D 420 mm Order No. 3223-65

Tambour door cabinet with lateral file pockets, 4 adjustable shelves. Carcass RAL 7021 anthracite, tambour door in beech finish (upcharge option). H 1660 x W 1200 x D 420 mm Order No. 3213-65

All shelves are height adjustable on a 15 mm roster punched into the side skins. File storage and lateral file pocket storage are possible with the cabinet roof offering an extra row for lateral files. Evenly distributed, the shelves carry a load of up to 50 kgs.



Incredible capacity!

Customers experienced in the use of lateral file pockets will have come to appreciate their versatility. Ideal for just a few documents or a small folder they do not require pull-out rails and depending on design will remain in the cabinet when documents are added or removed. The Omnispace series offer perfect sizes for the use of lateral file pockets from 2 to 6 levels. The universal construction of the shelves ensures a flexible approach to changes in the filing method, thus giving good performance and reliability.

1 Tambour door cabinet with lateral files, 5 adjustable shelves. Carcass and door in RAL 7021 anthracite. H 1980 x W 1200 x D 420 mm Order No. 3203-65

2 Tambour door cabinet with lateral files, 2 adjustable shelves. Carcass and door in RAL 7021 anthracite. H 1030 x W 1200 x D 420 mm Order No. 3243-65

All colours, finishes and accessories currently available are shown on pages 14 + 15.



1

2

All models and size variations at a glance

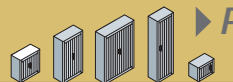

► Page 16



Omnispace desk height cabinets are especially suited for location at the workstation. There they provide a practical storage solution for everything needed close to the workstation whilst providing an additional hard wearing work surface for paper, fax machine or printer. Beyond this function, they allow planners to divide and organise office space in an attractive way.

Everything close to hand and under control

1 Tambour door cabinet with 1 adjustable shelf. Carcass and door in RAL 9006 white aluminium
H 720 x W 800 x D 420 mm
Order No. 3251-00

Added top in maple laminate finish 5000-04

2 Tambour door cabinet as above but with door in maple finish (upcharge option)
Order No. 3251-00

Added top in maple laminate finish 5000-04

3 Tambour door cabinet as above but with carcass and door in RAL 7021 anthracite
Order No. 3251-00

Added top in beech laminate finish 5000-05

All colours, finishes and accessories currently available are shown on pages 14 + 15.



Tambour door cabinet, 1 adjustable shelf.
Carcass and door in RAL 7035 light grey.
H 720 x W 800 x D 420 mm
Order No. 3251-65

Added top in light grey laminate finish 5000-00



All models and size variations at a glance

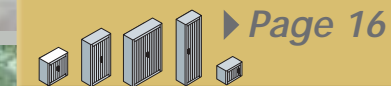

Colours, materials and accessories

Three standard carcass colours.



RAL 7035 light grey
RAL 7021 anthracite
RAL 9006 white aluminium

5 standard finishes for the easy-slide tambour doors:

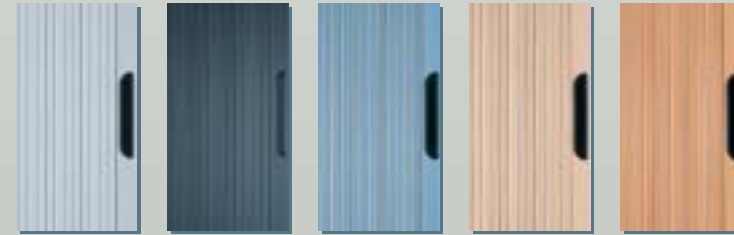

light grey anthracite white aluminium maple beech

Tops are 25 mm thick, with 3 mm edging available in three finishes:



maple laminate finish 5000-04
beech laminate finish 5000-05
light grey 5000-00

Several clever interior fitment solutions ensure the Omnispace tambour door cabinets can be utilised with maximum efficiency. The illustration below shows just some of the many possibilities. The available accessories incl. Order No.'s. are shown in detail on page 17.



Pull-out wardrobe rod



File suspension bars
TUB l'oblique files



Suspension bar
for Elba/Leitz



Adjustable shelf dividers



Pull-out work shelf,
approx. 490 mm wide



Multidrawer unit with
15 or 20 drawers



Pull-out suspension frame on
ball bearing slides



The Omnispace shelves can be used for storing files, other materials and for lateral file pockets.

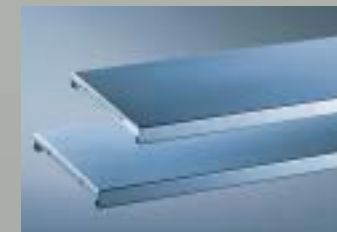

Everything at a glance

The Omnispace series of cabinets provide the solution for all office storage requirements. A choice of seven heights and four widths gives customers an nearly endless choice. Combined with the intelligently designed interior fitments (page opposite) choosing Omnispace means choosing a future proof storage system. Omnispace by C+P – more capacity on a smaller footprint.

	Cabinet width	Tambour door opens to the left		Tambour door opens to the right		File height	Lateral file levels	
		600	600	800	1000			1200
	Cabinet depth	420	420	420	420	420		
	Cabinet height 1980 mm						5	-
	Interior system for files	3200-00L	3200-00R	3201-00	3202-00	3203-00	-	-
	Interior system for lateral files	3200-65L	3200-65R	3201-65	3202-65	3203-65	-	6
	Without interior system	3200-01L	3200-01R	3201-01	3202-01	3203-01	-	-
	Cabinet height 1660 mm						4	-
	Interior system for files			3211-00	3212-00	3213-00	-	-
	Interior system for lateral files			3211-65	3212-65	3213-65	-	5
	Without interior system			3211-01	3212-01	3213-01	-	-
	Cabinet height 1345 mm						3 1/2	-
	Interior system for files			3221-00	3222-00	3223-00	-	-
	Interior system for lateral files			3221-65	3222-65	3223-65	-	4
	Without interior system			3221-01	3222-01	3223-01	-	-
	Cabinet height 1230 mm						3	-
	Interior system for files			3231-00	3232-00	3233-00	-	-
	Interior system for lateral files			3231-65	3232-65	3233-65	-	3
	Without interior system			3231-01	3232-01	3233-01	-	-
	Cabinet height 1030 mm						2 1/2	-
	Interior system for files			3241-00	3242-00	3243-00	-	-
	Interior system for lateral files			3241-65	3242-65	3243-65	-	3
	Without interior system			3241-01	3242-01	3243-01	-	-
	Cabinet height 720 mm						1 1/2	-
	Cabinet incl. top shelf			3251-00			-	-
	Interior system for files			3251-65			-	2
	Without interior system			3251-01			-	-
	Cabinet height 450 mm						1	-
	Interior system for files	3260-00L	3260-00R	3261-00	3262-00	3263-00	-	-
	Interior system for lateral files	3260-65L	3260-65R	3261-65	3262-65	3263-65	-	1
	Without interior system							
	Top, height 25 mm							
	Maple laminate finish 5000-04			3212-08	3212-10	3212-12		
	Beech laminate finish 5000-05							
	Light grey laminate finish 5000-00							

The right solution for any application

Omnispace tambour door cabinets are available in three versions:

- for use with lever arch files
- for use with lateral file pockets
- without interior fitments

Often the difference in the product codes for -00 and -05 models is only the numbers of shelves leaving the shelf itself to be used for lateral filing or lever arch files making it easy to change your filing system at some future date.

The empty cabinets provide the basis for customised interiors according to clients' requirements.

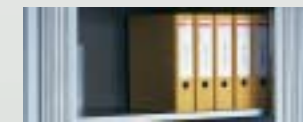

Cabinets ending in **-00** are designed for **standard files**

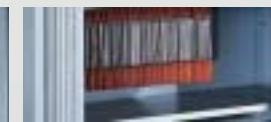





Cabinets ending in **-65** are designed for **lateral file pockets**

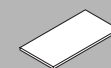

Cabinets ending in **-01** are **empty**, designed for individual customer configuration

Omnispace tambour door cabinet external and usable dimensions:

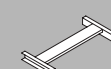
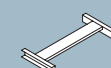
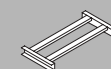
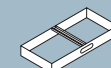
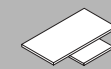
Outer height > inner height		Outer width > inner width		Outer depth > inner depth	
1980	> 1836	1200	> 1051	420 > 385/360	
1660	> 1516	1000	> 851	(Inner dimension 385 mm, shelf 360 mm)	
1345	> 1201	800	> 651		
1230	> 1086	600	> 493		
1030	> 886				
720	> 596				
450	> 356				

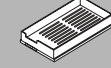
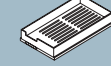
interior system	for 600 mm in width	for 800 mm in width	for 1000 mm in width	for 1200 mm in width
 Lateral filing shelf	Order No. 3200-80	Order No. 3201-80	Order No. 3202-80	Order No. 3203-80
 Adjustable shelf dividers	Order No. 4221-25	Order No. 4221-25	Order No. 4221-25	Order No. 4221-25
 Suspension bar for the Elba / Leitz system	Order No. 3200-82	Order No. 3201-82	Order No. 3202-82	Order No. 3203-82
 Suspension bar for the Zippel system	Order No. 3200-83	Order No. 3201-83	Order No. 3202-83	Order No. 3203-83
 Suspension bar for TUB l'oblique files bars	Order No. 3200-85	Order No. 3201-85	Order No. 3202-85	Order No. 3203-85
 Suspension frame fully pull-out for DIN A4 suspension files (safety catch required if more than two suspension frames)	-	Order No. 3201-811	Order No. 3202-811	Order No. 3203-811
 Shelf with pull-out work shelf approx. 490 mm in width	-	Order No. 3201-871	Order No. 3202-871	Order No. 3203-871
 Shelf with pull-out wardrobe rod (hangers not included)	Order No. 3200-88	Order No. 3201-88	-	-
 Plastic drawer unit with 15 drawers	-	Order No. 3201-702	-	-
 Plastic drawer unit with 20 drawers	-	-	-	Order No. 3203-702



Office Furnishing Expertise from C+P

C+P supply much more than the excellent Omnispace series of storage cabinets. Making interiors work is our business and should you require assistance in planning and furnishing:

- offices and archives
- changing- and wardrobe facilities
- contract interiors

we should be delighted to discuss your requirements.

Your local dealer will be pleased to visit you.



Office and archive furnishing systems

Office furniture from C+P covers a large spectrum of furniture for business – from solutions for clerical workstations through to executive offices – from desks and containers through to storage solutions. A perfect example is the workstation Workflow® by C+P for use sitting down or standing up as required or desired.

Workflow® brings together the VDU workstation, the stand-up work surface and the meeting extension into one workplace and is thus the perfect workstation for the teamworker.



Changing room and wardrobe systems

C+P is one of the market leaders in Europe supplying changing room and wardrobe cabinets and systems. C+P cabinet systems are used for common rooms, sports facilities, schools, fitness studios, leisure facilities, pools, fire brigades, reception areas, offices and others. C+P provides tailor made solutions. And with innovations such as the self-ventilation concept or the floor raised changing cabinets we keep one step ahead.

C+P is one of the foremost furniture manufacturers in Europe.

Continuous innovation, regular investments and market led products are guarantors for C+P quality and performance.

Our clients know they can rely on C+P for the best solutions.

Our quality management system is ISO 9001 certified.

Many of our products carry the GS-Certificate (tested for safety symbol) having passed tests at the test facilities RW-TUV and TUV Thüringen. We should be pleased to provide copies of certificates if required.



ID-Collection

Contract furniture or design object?

The ID collection provides integrated contract furniture for all applications. From A-Z it enhances our clients' interiors or it shines in its own right. Top in design and quality, the ID collection speaks for itself, especially when a certain touch of class is required.

Furniture for people

